

SIGN-WARE® GERMANY

It's my system.

sign-ware.de

Trau
Hochzeit

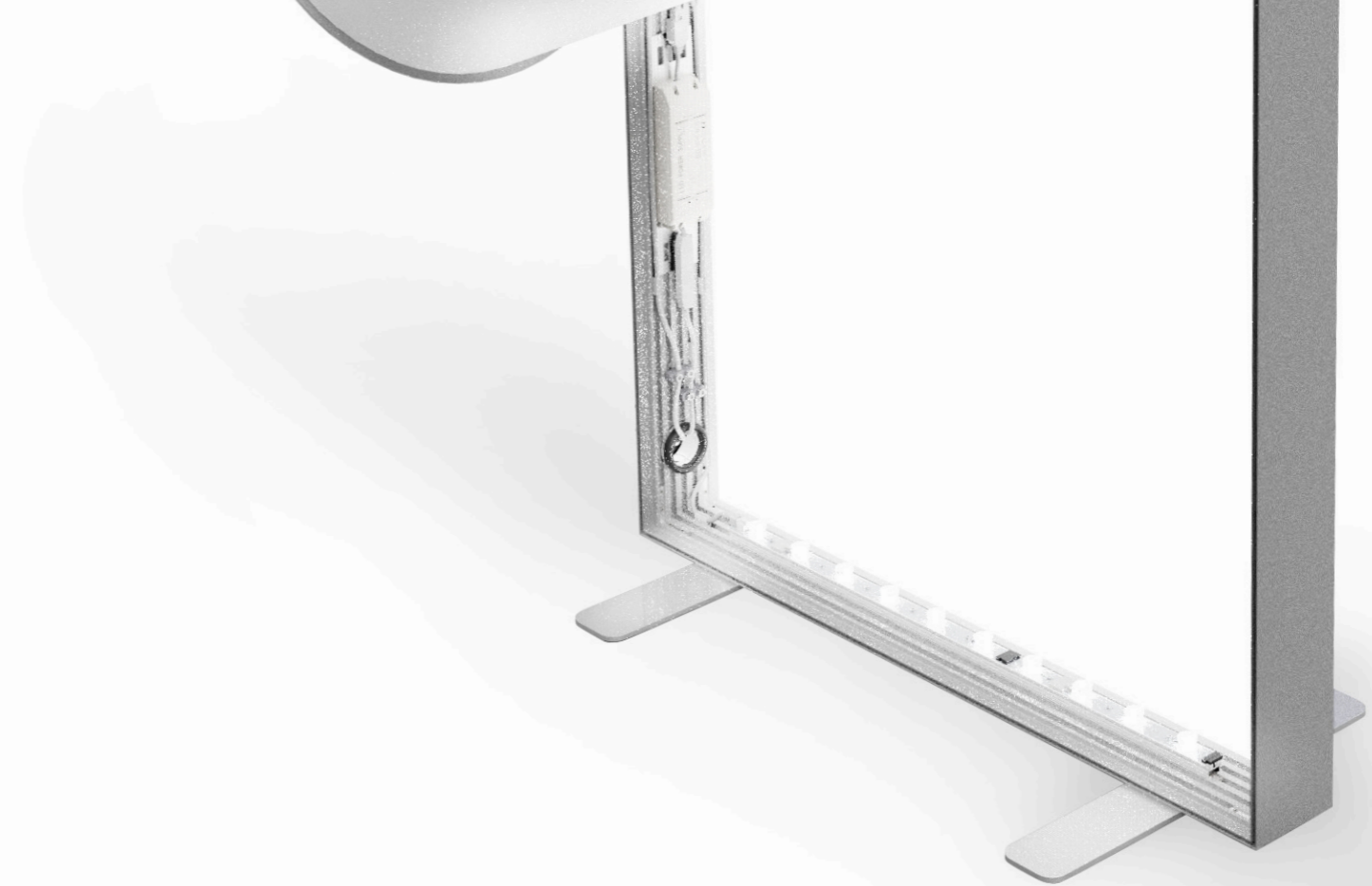



PROFITIEREN SIE VOM SIGN-WARE-KNOW-HOW

SIGN-WARE-Produkte verleihen Ihren individuellen Designideen Raum: Gestalten Sie Wand, Decke und Raum – unsere langjährige Expertise in der Verarbeitung von verschiedensten Aluminiumprofilen macht es möglich. Profitieren Sie dabei von dem Know-how der Profis: Vertrauen Sie unserer umfangreichen Projektkompetenz und holen Sie sich mit SIGN-WARE einen erfahrenen Partner in Ihr Planungsteam.

BENEFIT FROM SIGN-WARE'S KNOW-HOW

SIGN-WARE products give space to your individual design ideas: Our long-standing expertise in processing different aluminum profiles enables you to design walls, ceilings and space according to your individual taste. When doing so, take advantage of our professionals' know-how: Rely on our comprehensive project competence and take an experienced partner on board of your planning team with SIGN-WARE.

INNOVATIVE TRÄGERSYSTEME FÜR DIGITALE GROSSBILDER

Rahmensysteme zum Spannen von Textilien für den Innen- und Außenbereich – das ist seit vielen Jahren die Kernkompetenz von SIGN-WARE. Im Jahre 2001 aus dem 120-jährigen Traditionsunternehmen Franz Miederhoff hervorgegangen, entwickeln und produzieren wir innovative Trägersysteme für digitale Großbilder. Mit der Ausgliederung in eine eigenständige GmbH & Co. KG wurde 2007 der nächste Meilenstein gesetzt.

Mittlerweile beschäftigen wir 42 Mitarbeiter am Standort Sundern-Endorf im Sauerland. Insgesamt elf Planer aus den Bereichen Technik und Vertrieb widmen sich Tag für Tag Ihren Ideen und Wünschen. Ein breites Produktportfolio ermöglicht Ihnen dabei optimale Lösungen für die verschiedensten Anwendungen: Ob einfacher Rahmen oder Messestand, Lift-Systeme oder Fassadenverkleidungen – mit SIGN-WARE sind der Kreation von Form und Funktion kaum Grenzen gesetzt.

INNOVATIVE DISPLAY SYSTEMS FOR LARGE DIGITAL PRINTS

Frame systems for spanning textiles indoors and outdoors – that has been SIGN-WARE's core competency for many years. In 2001, we have emerged from the 120-year-old traditional business Franz Miederhoff, developing and producing innovative display systems for large digital prints. By becoming an independent limited liability company in 2007, we had set our next milestone.

Today, we are employing 42 people at our headquarters in Sundern-Endorf (Sauerland), Germany. Each and every day, eleven team members from Engineering and Sales are dedicating their entire work to your ideas and demands. Our broad product portfolio enables them to find the optimum solution for various applications: No matter if a simple frame or trade show booth, lift systems or fabric architecture is required – there are no limits of form and function with SIGN-WARE's expertise.





FitFRAME LED FREISTEHEND FREESTANDING



FitFRAME LED WAND WALL



PERFEKT FIT: FitFRAME LED

Kreieren Sie Ihre eigenen Erlebniswelten – mit dem praktischen FitFRAME-System. Durch die große Bandbreite an Schienenvarianten finden Sie garantiert das richtige Profil für Ihre Anwendung.

Dank hocheffizienter LED-Technik aus deutscher Herstellung kommt Ihre Werbung noch besser an – hinterleuchtete Textildrucke setzen besondere Akzente: Egal ob auf der Messe, im Ladenbau oder bei ganz individuellen Aufträgen.

PERFECT FIT: FitFRAME LED

Create your own worlds of experience – with the practical FitFRAME system. The wide selection of rails guarantees that you can find the right profile for your application.

Thanks to highly efficient LED technology made in Germany, your advertisement is made even more appealing – backlit fabric prints create special accents: no matter whether they are used at a trade fair, as a shop fixture or for any special purposes.

FitFRAME LED ABGEHÄNGT SUSPENDED





FLEXIBLE MODULE

Einfache Handhabung bei maximaler Stabilität: Das ist das FitFRAME LED Prinzip.

Aufgrund des optimalen Verhältnisses von Schienendicke, -stabilität und -handlichkeit ist FitFRAME LED für einen schnellen Auf- und Abbau und einen komfortablen Transport bestens geeignet.

Dank der zahlreichen Kombinationsmöglichkeiten werden Messestände mit FitFRAME LED zum absoluten HighLIGHT: Die hohe Strahlkraft der LED-Beleuchtung ist wiederverwendbar und stets sicher durch die VDE- und TÜV-geprüfte Abhängung.

FLEXIBLE MODULES

Easy to use with maximum sturdiness: this is the principle of FitFRAME LED.

Due to its optimal balance of rail thickness, sturdiness and handiness, FitFRAME LED is ideally suited for quick assembly and dismantling, and convenient transport.

Trade fair stands equipped with FitFRAME become a real highlight thanks to the many possible combinations: The high radiant intensity of the LED lighting can be reused and is always secure thanks to the VDE- and TÜV-certified suspension system.

FitFRAME LED FREISTEHEND FREESTANDING



FitFRAME LED ABGEHÄNGT SUSPENDED





PLUG & PLAY

Plug & Play für alle FitFRAME Profile

- Steckerfertiges Gesamtsystem
- Einfache und schnelle Montage
- Modular erweiterbar
- Geprüfte Sicherheit

Designed,
developed and
made in Germany

PLUG & PLAY

Plug and play for all FitFRAME profiles

- Complete system ready to plug in
- Simple and quick installation
- Modularly expandable
- Certified safety

LED MODUL

LED Lichttechnik Made in Germany

- Homogene Lichtverteilung
- Hohe Lichtausbeute
- Farbtreues LED Binning
- Dimm- und ansteuerbar
- Zertifiziert durch Verband der Elektrotechnik (VDE)



LED MODULE

LED Lichttechnik Made in Germany

- Homogeneous light distribution
- High level of light output
- LED binning with high colour fidelity
- Dimmable and controllable
- Certified safety by VDE
(Association of electrical engineering)

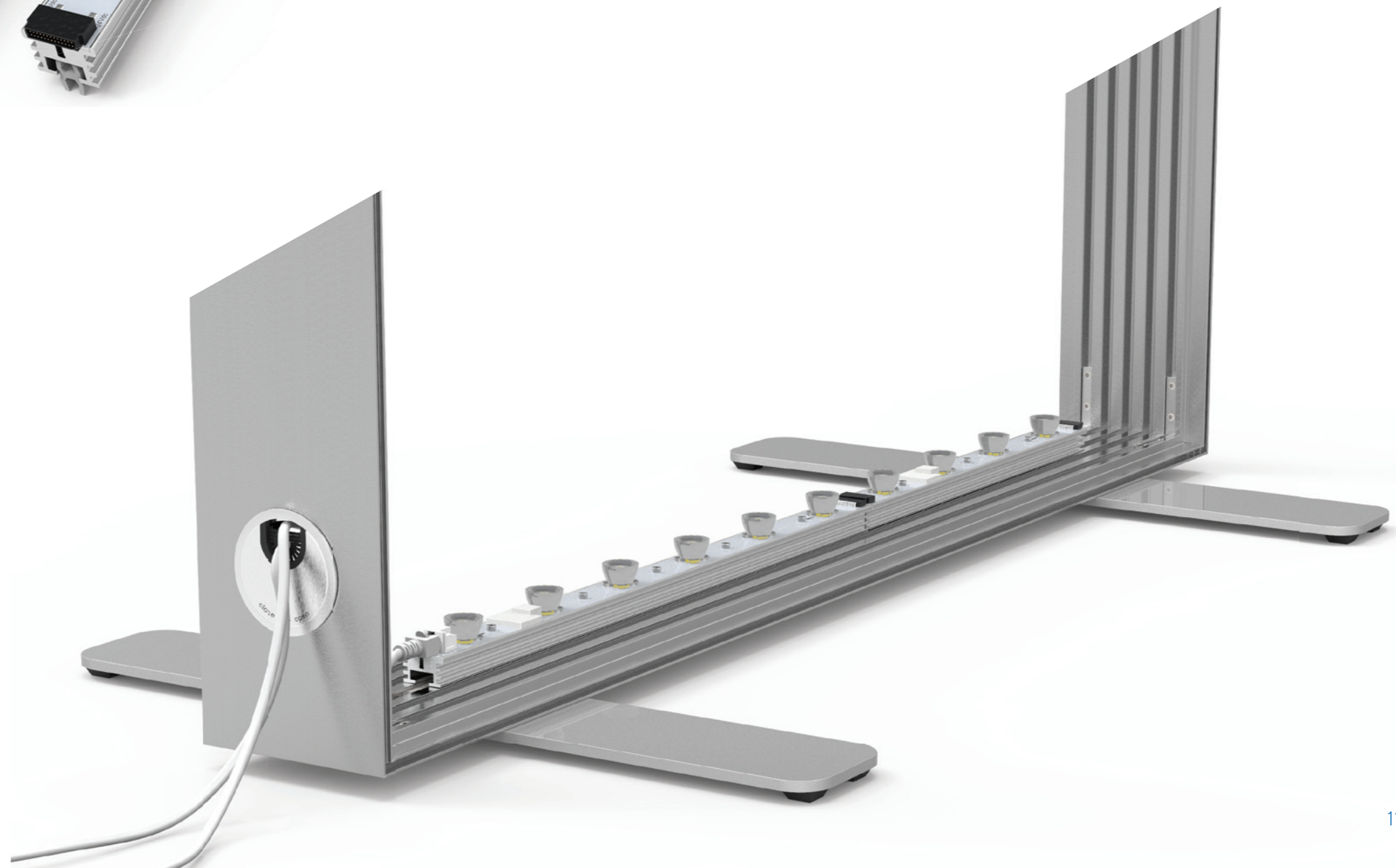



PLUG & PLAY

FitFRAME LED
Patchkabel
25.2100.07

patch cable



FitFRAME LED
Netzgerät 100 W
25.0241.00

Power Supply 100 W

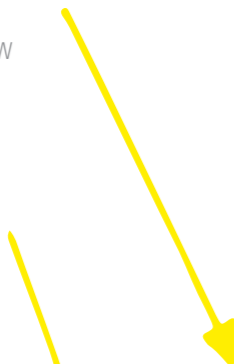

FitFRAME LED
Zugentlastung
25.3071.44

Strain-Relief



FitFRAME LED
Kabeldurchführung
25.3060.00

cable bushing



FitFRAME LED
Modul 465-KW-E
25.0465.02

Module 465-KW-E



FitFRAME LED
Modul 310-KW-D
25.0310.08

Module 310-KW-D

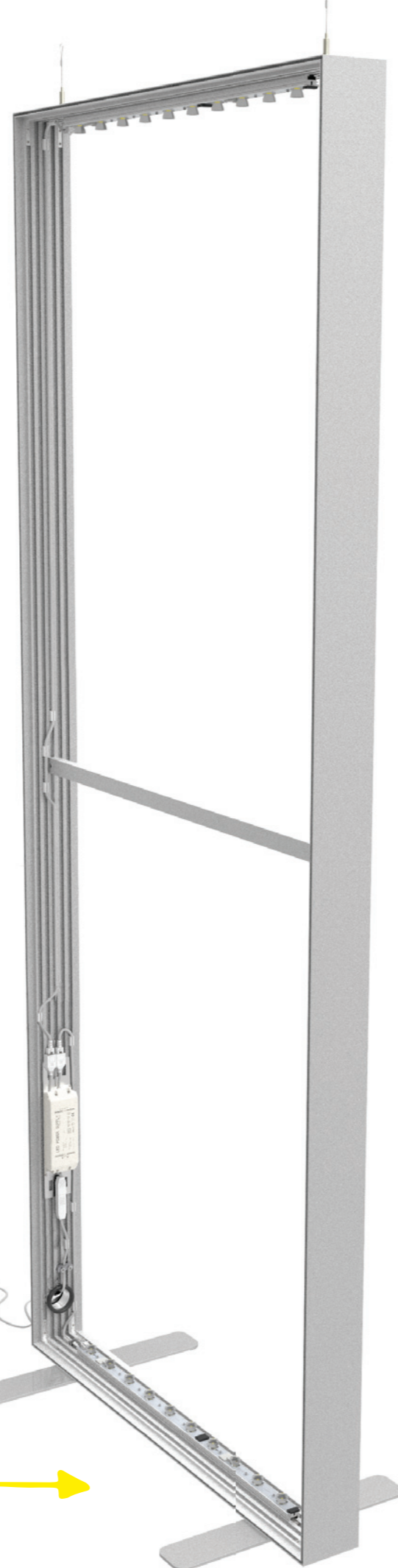

SYSTEM

Mit dem gewohnten SIGN-WARE-Qualitätsstandard. Auch bei den LED Komponenten verlassen wir uns auf spezialisierte Partner mit Produkten aus deutscher Produktion.

Durch auf die Anwendung in einem geschlossenen Spanntuchrahmen optimierten Kühlkörper werden die LED-Komponenten im niedrigst möglichen Temperaturbereich gehalten. Der Vorteil: hohe Lebensdauer der LED-Komponenten, wartungsarm. Festgelegte Binnings (Lichtfarbe) und optimierte optische Systeme sorgen bei den LED für homogene Lichtwirkung. Das erleichtert spätere Erweiterung und den möglichen Austausch von Komponenten. ESD-geschützte Verpackungsmaterialien sorgen für sicheren Transport und sichere Lagerung bis zum Wiederaufbau.

VDE- und CE-zertifizierte Fertigung in Deutschland. LED-Modul und Produktion sind durch den Verband der Elektrotechnik (VDE) auf Betriebssicherheit überprüft, zum Einbau in die SIGN-WARE-Rahmen freigegeben.

LED LICHTTECHNIK

Bilder und Werbebotschaften erstrahlen gestochen scharf. Neue Akzente für moderne, zeitgemäße und vor allem wirkungsvolle Werbung. Das innovative SIGN-WARE-System für Textildrucke, kombiniert mit den exzellenten Vorteilen der LED-Technologie.

In Kooperation mit einem spezialisierten Hersteller von Lichtlösungen für die Werbebranche, aus deutschen Fertigungsstätten, ist ein überzeugendes, völlig neuartiges Produkt entstanden: FitFRAME LED. Angepasst an das komplette SIGN-WARE-Schienensystem, kompatibel durch die patentierten x-Clips, erstrahlt Werbung NEU. Modular anpassbar.

GEPRÜFTE SICHERHEIT

Die LED-Komponenten für die Schienensysteme kommen in der bewährten SIGN-WARE-Qualität: Sicherheit und Verlässlichkeit im täglichen Einsatz werden dokumentiert durch die Zertifizierung der Elemente seitens des VDE.

SYSTEM

Made to the same SIGN-WARE quality standard. For the LED components, we also rely on specialist partners that make their products in Germany.

By using an optimised heat sink in a closed banner frame, the LED components are kept running at the lowest temperature range possible. The benefit of this is that the LED components have a longer service life and require little maintenance. Predefined binning (light colours) and optimised optic systems ensure that the LEDs produce a homogenous lighting effect. This facilitates the subsequent expansion of the system and the possible replacement of components. ESD-protected packaging materials ensure safe transport and storage until the next assembly.

VDE- and CE-certified production in Germany. The LED module and production are audited by VDE for their operational safety and have been approved for use in SIGN-WARE frames.

LED LIGHTING TECHNOLOGY

Images and advertisement messages appear razor-sharp. New accents for modern, contemporary and, most importantly, effective advertising. The innovative SIGN-WARE system for fabric prints, combined with the excellent benefits of LED technology.

In collaboration with a specialist manufacturer of lighting solutions for the advertising industry, an outstanding and absolutely innovative product has been produced by German manufacturing facilities: FitFRAME LED. Customised for the complete SIGN-WARE rail system and compatible through the patented x-clips, the LEDs adds a NEW glow to advertisements. Modularly customisable.

CERTIFIED SAFETY

The LED components for the rail systems are made to the proven SIGN-WARE quality standard: The VDE certification is a testimony of the safety and reliability of the elements in everyday use.



HELLIGKEIT

Maximale Lichtleistung für jede Anwendung bei bis zu 6500 Lumen je Meter bei doppelseitiger Lichteinspeisung. Eines der hellsten Systeme am Markt, mit bis zu 160 Candela je Kilolumen. Hohe Lichtausbeute von 100 Lumen je Watt durch optimierte Steuernetzgeräte. Festgelegtes LED Binning (Lichtfarbe) mit einer Farbtemperatur von 6500 Kelvin. Die FitFRAME LED Module gibt es in der Ausführung 310 mm (1000 Lumen) und 465 mm (1500 Lumen).

BRIGHTNESS

Maximum lighting performance for every application at up to 6500 lumens per metre when using double-sided light input. One of the brightest systems on the market, at up to 160 candelas per kilolumen. High level of light output of 100 lumens per watt through the use of optimised control devices. Predefined LED binning (light colour) with a colour temperature of 6500 kelvin. The FitFRAME LED module is available in the sizes 310 mm (1000 lumens) and 465 mm (1500 lumens).



HOMOGENITÄT

Auf die Anwendung in FitFRAME angepasste Linsenoptik. Gleichmäßiger Abstand der LED-Elemente, angepasst an das Kühlprofil, dadurch Homogenität bis in die Randbereiche. Homogene Lichtwirkung durch chargenunabhängige Farbtemperatur, auch beim Einsatz mehrerer Systeme in Kombination durch Dimmer.

HOMOGENEITY

LED optic customised for use in FitFRAME. LED elements are evenly spaced and customised for the cooling profile, resulting in homogeneous lighting even at the edges. Homogenous lighting effect made possible through consistent colour temperature regardless of batch, even when using several systems in combination with a dimmer.

QUALITY

High-performance LED: Predefined binning (light colour) for perfect colour fidelity. RIPs do not have to be readjusted. Flicker-free to the eyes and camera: 800 Hz operating frequency, optimal for TV and photo production. Low light loss even after a long operating time (after 50,000 operating hours, it is guaranteed that the LED will retain 80% of the original light output) due to the customised heat sink.

QUALITÄT

Hochleistungs LED: Festgelegtes Binning (Lichtfarbe) für exakte Farbtreue, RIPs müssen nicht erneut angepasst werden. Flicker Free für Auge und Kamera: 800 Hz Betriebsfrequenz, optimal bei Anwendungsbereichen für TV und Foto. Geringer Helligkeitsverlust auch bei hoher Betriebsdauer (nach 50.000 Betriebsstunden garantiert noch 80 % der Ausgangshelligkeit) durch angepassten Kühlkörper.



Zertifizierte Qualität

Certified quality



ELEKTRISCHE VERBINDUNG

Das System arbeitet mit Schutzkleinspannung und bedarf keiner elektrotechnischen Fachkraft zur Inbetriebnahme. Durch unser simplifiziertes Stecksystem gewähren wir einen reibungslosen Aufbau für jede Anforderung. Die einfache Plug & Play-Montage reduziert auch bei komplexen Anwendungen Aufbauzeiten und -kosten. Eine einheitliche Verwendung von RJ45 Steckverbindungen in jeder Komponente vereinfacht die Montage und lässt sich selbst von Laien durchführen. Die Verbindungen sind hochwertig ausgeführt und alle elektronischen Bauteile sind zusätzlich zu ihrem Schutz auf dem LED Modul vergossen.

ELECTRICAL CONNECTION

The system operates on safety extra-low voltage and does not require a certified electrician to set up. Thanks to our simplified plug-in system, we ensure a smooth assembly process for every requirement. The simple plug-and-play installation reduces assembly time and costs, even for complex applications. The standardised use of RJ45 connectors in every component simplifies the assembly process, allowing even a layperson to assemble the system. The connectors are of premium build quality, and all electronic components are also moulded to protect them on the LED module.

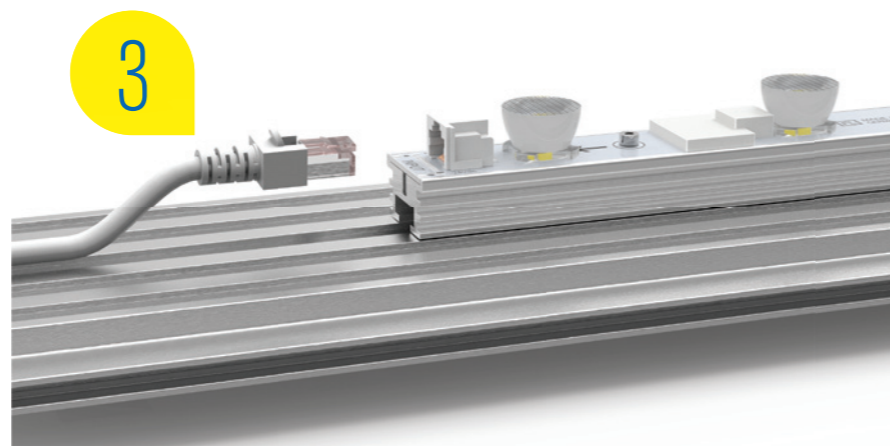
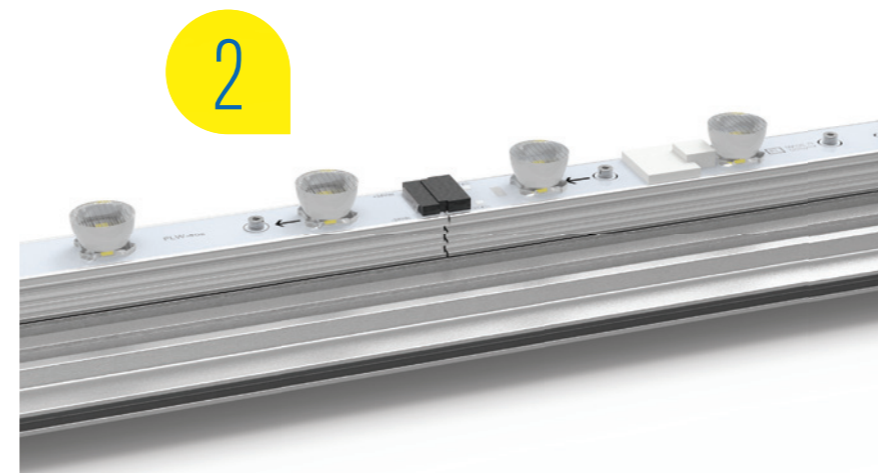
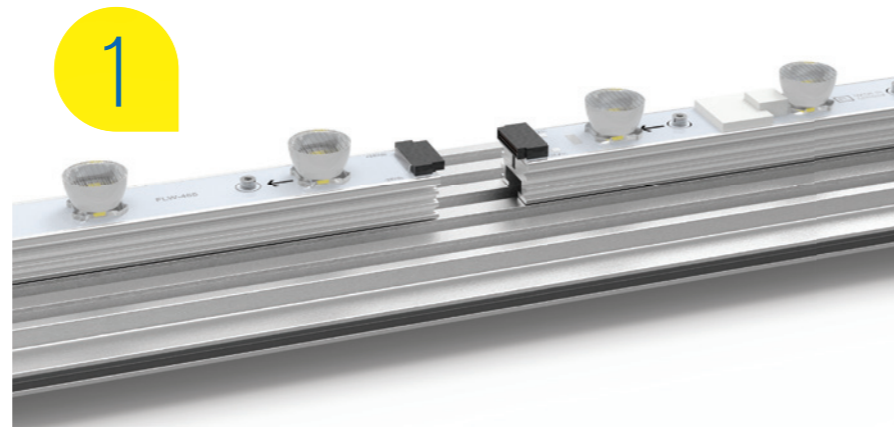

SICHERHEIT

In Deutschland produziert und zur Qualitätssicherung kontinuierlich fertigungsüberwacht. Das Netzgerät ist auf elektromagnetische Verträglichkeit (EMV) TÜV geprüft. LED Modul und Gesamtsystem sind für Einbau in SIGN-WARE-Rahmen freigegeben und die Sicherheit in einem Überwachungsgutachten vom VDE bescheinigt. Der Lieferumfang umfasst das komplette System, den FitFRAME LED Rahmen inklusive aller Komponenten. Das reduziert mögliche sicherheitstechnische Fehlerquellen, etwa beim eventuellen Einbau von Dritthersteller-Komponenten.

MECHANISCHE VERBINDUNG

Alle FitFRAME LED Module können in den bewährten FitFRAME Aufnahme kanal montiert werden. Durch Integration des Befestigungsclips in den Kühlkörper können Module werkzeugfrei, schnell und einfach montiert werden. Die Erweiterung eines LED Stranges erfolgt über simples Einclippen und Zusammenschieben der Module. Mehrere LED Module können so in schneller Montagezeit verbunden werden.

MECHANICAL CONNECTION

All FitFRAME LED modules can be installed in the time-proven FitFRAME strut channel. By integrating the attachment clips into the heat sink, modules can be quickly and easily installed without the need for tools. The expansion of an LED strip is carried out by simply clipping it in and shifting the modules together. This allows several LED modules to be quickly connected.

SAFETY

Products are made in Germany, and production is continuously monitored for quality assurance. The power supply unit is tested by TÜV for its electromagnetic compatibility (EMC). The LED module and the overall system are approved for use in SIGN-WARE frames and certified safe by VDE through an assessment. The delivery package contains the complete system and the FitFRAME LED frame, including all components. This reduces any sources of safety-related error such as when installing third-party components.



STEUERUNGEN

Steuerungen können ebenfalls steckerfertig per Plug & Play montiert werden und so die Hinterleuchtung intelligent erweitern. Sie sind in unterschiedlichen Konfigurationen und Schnittstellen verfügbar und ermöglichen die Helligkeitsanpassung, Einbindung von Tastern/Bewegungsmeldern und die Einbindung in Systeme der Gebäudeautomatisierung.



CONTROLLERS

Controllers can likewise be installed using plug and play, allowing the backlight to be expanded with an intelligent system. The controllers are available in different configurations and with different interfaces and enable automatic brightness adjustment, integration of touch and motion sensor, and integration into building automation systems.

		MANUELL	MANUALLY	0 - 10 V	0 - 10 V	BLUETOOTH	BLUETOOTH
BAUART	TYPE	Dimmung über Drehpoti	Dimming using a rotary potentiometer	Dimmung über Eingangsspannung 0 - 10 V	Dimming using input voltage 0-10 V	Dimmung über IOS App oder Tasterkontakt	Dimming using an iOS app or push-button contacts
INSTALLATION	INSTALLATION	Plug & Play hinter dem Netzgerät	Plug and play behind the power supply	Plug & Play hinter dem Netzgerät	Plug and play behind the power supply	Plug & Play hinter dem Netzgerät	Plug and play behind the power supply
ANWENDUNG	APPLICATION	Einmalige Helligkeitsanpassung bei Montage	One-off brightness adjustment during installation	Einbindung in ein bestehendes Lichtsteuersystem	Integration into an existing lighting control system	Aufbau eines Lichtsteuernetzwerkes auf Funkbasis	Setting up a wireless lighting control network
ANWENDUNG AN BESTEHENDES LICHTSTEUERSYSTEM	APPLICATION TO AN EXISTING LIGHTING CONTROL SYSTEM	-	-	0 - 100 %	0 - 100 %	0 - 100 %	0 - 100 %
ERSTELLEN VON LICHTSZENEN UND ANIMATIONEN	CREATING LIGHTING SCENES AND ANIMATIONS	-	-	Über bestehendes Lichtsteuersystem	Using an existing lighting control system	Casambi	Casambi
NETZWERK, REICHWEITE	NETWORK, RANGE	-	-	-	-	Bluetooth, bis zu 50 m von Lichtwand zu Lichtwand	Bluetooth, up to 50 metres from light wall to light wall
GRUPPIERUNG VON LICHTWÄNDEN	GROUPING OF LIGHT WALLS	-	-	-	-	Ja, via kostenloser App	Yes, using a free app
TASTERKONTAKT ZUM AUSLÖSEN VON LICHTSZENEN	PUSH-BUTTON CONTACTS FOR TRIGGERING LIGHTING SCENES	-	-	-	-	Ja	Yes

STEUERUNG BLUETOOTH

Nutzerfreundliche Einrichtung über kostenlose Casambi App (verfügbar im App Store für iOS und Google Play Store für Android). Konfiguration von Lichtszenarien, die über die App oder Bluetooth Taster abgerufen werden können. Einfacher Aufbau eines Netzwerkes von mehreren Lichtwänden mit einem Abstand von bis zu 50 m von Lichtwand zu Lichtwand. Zusätzlicher potentialfreier Tasterkontakt zur Integration von Bewegungsmeldern und konventionellen Tastern.

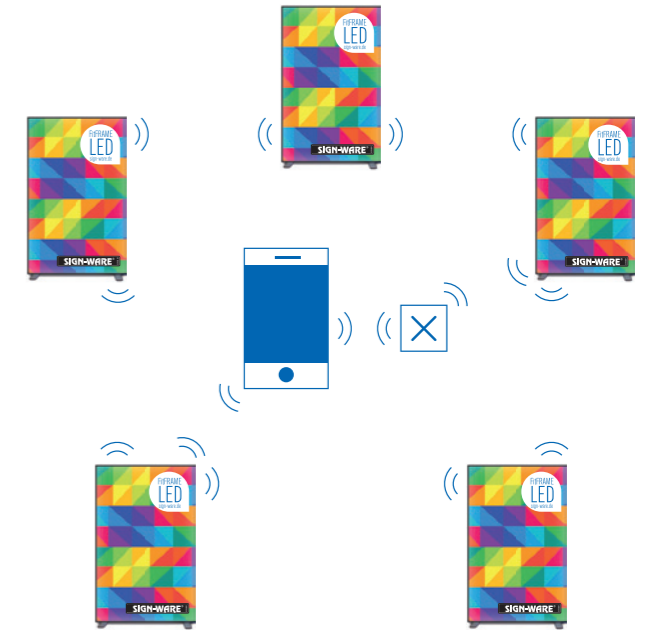

BLUETOOTH CONTROLLER

User-friendly configuration in free Casambi App (available in the App Store for iOS and Google Play Store for Android). Configuration of lighting scenes can be retrieved using the app or Bluetooth push-buttons. It is easy to set up a network consisting of several light walls with a distance of up to 50 metres from wall to wall. Additional volt-free push-button contacts for integrating motion sensors and conventional push-buttons.



STEUERUNG 0 - 10 V

Einbindung in bestehende Lichtsteuerungssysteme und Gebäudeautomatisierungen. Herstellerunabhängig über das 0-10 V-Steuersignal integrierbar.

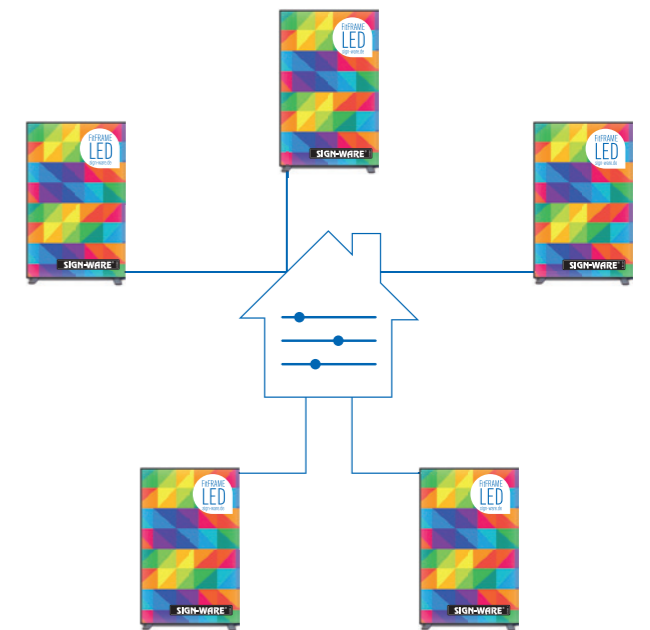

0 - 10 V CONTROLLER

Integration into existing lighting control systems and building automation systems. Can be integrated into systems made by any manufacturer using the 0-10 V control signal.

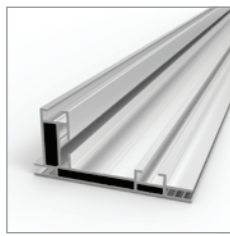

<p>FitFRAME Schiene lightbox 100 Aluminium eloxiert</p> <p>29.0100.31 ← L = 6060 mm 59.0100.31 ← Zuschnitt berechnet in mm, ohne Gehrungsschnitt</p>	<p>FitFRAME rail lightbox 100 aluminium anodised</p> <p>L = 6060 mm extrusion cut calculated in mm, excluding mitre cut</p>	
<p>B/W: 100 mm H: 45 mm T/D/L: 6060/1000 mm \pm 10260/167000 g VPE/PU: 1</p>		



<p>FitFRAME Schiene duo120 smart Aluminium eloxiert</p> <p>29.1119.31 ← L = 6060 mm 59.1119.31 ← Zuschnitt berechnet in mm, ohne Gehrungsschnitt</p>	<p>FitFRAME rail duo120 smart aluminium anodised</p> <p>L = 6060 mm extrusion cut calculated in mm, excluding mitre cut</p>	
<p>B/W: 119 mm H: 15 mm T/D/L: 6060/1000 mm \pm 9980/16500 g VPE/PU: 1</p>		



<p>FitFRAME Schiene duo160 smart Aluminium eloxiert</p> <p>29.1159.31 ← L = 6060 mm 59.1159.31 ← Zuschnitt berechnet in mm, ohne Gehrungsschnitt</p>	<p>FitFRAME rail duo160 smart aluminium anodised</p> <p>L = 6060 mm extrusion cut calculated in mm, excluding mitre cut</p>	
<p>B/W: 159 mm H: 15 mm T/D/L: 6060/1000 mm \pm 13390/22100 g VPE/PU: 1</p>		

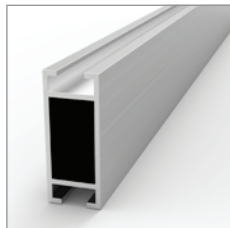

<p>FitFRAME Schiene Zarge Aluminium eloxiert</p> <p>29.0750.31 ← L = 6060 mm 59.0750.31 ← Zuschnitt berechnet in mm, ohne Gehrungsschnitt</p>	<p>FitFRAME rail sash aluminium anodised</p> <p>L = 6060 mm extrusion cut calculated in mm, excluding mitre cut</p>	
<p>B/W: 19 mm H: 46 mm T/D/L: 6060/1000 mm \pm 3720/614 g VPE/PU: 1</p>		



<p>FitFRAME Eckverbinder Stahl verzinkt</p> <p>29.0091.00 ← innen einfach 29.0161.00 ← innen einfach gebogen</p>	<p>FitFRAME corner connector steel zinc plated</p> <p>inside single inside single bent</p>	
<p>B/W: 97 mm H: 97 mm T/D/L: 4 mm \pm 110/440 g VPE/PU: 4/1</p>		



<p>29.1550.30 FitFRAME Eckverbinder 2D 15 x 50 mm für kleinen FitFrame Kanal</p>	<p>FitFRAME corner-connector 2D 15 x 50 mm for small FitFrame channel</p>	
<p>B/W: 15 mm H: 5 mm T/D/L: 50 mm \pm 17 g VPE/PU: 4</p>		



<p>29.0190.00 FitFRAME Zargenschloss inkl. Montage</p>	<p>FitFRAME sash lock incl. mounting</p>	
<p>B/W: 27 mm H: 15 mm T/D/L: 46,5 mm \pm 40 g VPE/PU: 1</p>		



<p>29.0044.10 FitFRAME Standfuß FLACH Stahl lackiert RAL 9006 Silbergrau</p>	<p>FitFRAME foot FLAT steel lacquered RAL 9006 silver-grey</p>	
<p>B/W: 80 mm H: 6 mm T/D/L: 500 mm \pm 1770 g VPE/PU: 1</p>		









<p>29.0080.00 FitFRAME Standfuß FLACH Stahl lackiert RAL 9006 Silbergrau</p>	<p>FitFRAME foot FLAT steel lacquered RAL 9006 silver-grey</p>	
<p>B/W: 130 mm H: 6 mm T/D/L: 800 mm \pm 5000 g VPE/PU: 1</p>		









<p>21.6048.12 Drahtseilhalter SW1.5B mit FitFRAME Nutenstein für Ø 1,5 mm Edelstahldrahtseil</p>	<p>Wire rope holder SW1.5B with FitFRAME sliding block for Ø 1.5 mm stainless steel wire</p>	
<p>T/D/L: 44 mm Ø: 10 mm \pm 19 g VPE/PU: 4</p>		









	25.0241.00	FitFRAME LED Netzgerät 100 W	FitFRAME LED power supply 100 W	
		prim. 230 V, sek. 24 Vdc Euroleitung 3000 mm, 800 Hz auf Montageplatte inkl. Befestigungsclips	prim. 230 V, sek. 24 Vdc supply line 3000 mm, 800 Hz on assembly sheet incl. assembly clips	
		B/W: 66 mm H: 34 mm T/D/L: 300 mm	680 g VPE/PU: 1	



	25.0241.01	FitFRAME LED Netzgerät Doppelbuchse	FitFRAME LED power supply double output	
		100 W, prim. 230 V, sek. 24 Vdc Euroleitung 3000 mm, 800 Hz auf Montageplatte inkl. Befestigungsclips	100 W, prim. 230 V, sek. 24 Vdc supply line 3000 mm, 800 Hz on assembly sheet incl. assembly clips	
		B/W: 66 mm H: 34 mm T/D/L: 300 mm	680 g VPE/PU: 1	



	25.0310.06	FitFRAME LED Modul 310-KW-E	FitFRAME LED module 310-KW-E	
		Einspeisung 24 Vdc, 9 W, 6500 K Platine FLW-310-KW-E auf Kühlkörper inkl. Befestigungsclips	input 24 Vdc, 9 W, 6500 K board FLW-310-KW-E on cooling element incl. assembly clips	
		B/W: 29 mm H: 29 mm T/D/L: 310 mm	241 g VPE/PU: 1	



	25.0310.08	FitFRAME LED Modul 310-KW-D	FitFRAME LED module 310-KW-D	
		Durchgang 24 Vdc, 9 W, 6500 K Platine FLW-310-KW-D auf Kühlkörper inkl. Befestigungsclips	transfer 24 Vdc, 9 W, 6500 K board FLW-310-KW-D on cooling element incl. assembly clips	
		B/W: 29 mm H: 29 mm T/D/L: 310 mm	241 g VPE/PU: 1	



	25.0465.02	FitFRAME LED Modul 465-KW-E	FitFRAME LED module 465-KW-E	
		Einspeisung 24 Vdc, 13,5 W, 6500 K Platine FLW-465-KW-E auf Kühlkörper inkl. Befestigungsclips	input 24 Vdc, 13,5 W, 6500 K board FLW-465-KW-E on cooling element incl. assembly clips	
		B/W: 29 mm H: 29 mm T/D/L: 465 mm	349 g VPE/PU: 1	

	25.0465.04	FitFRAME LED Modul 465-KW-D	FitFRAME LED module 465-KW-D	
		Durchgang 24 Vdc, 13,5 W, 6500 K Platine FLW-465-KW-D auf Kühlkörper inkl. Befestigungsclips	transfer 24 Vdc, 13,5 W, 6500 K board FLW-465-KW-D on cooling element incl. assembly clips	
		B/W: 29 mm H: 29 mm T/D/L: 465 mm	349 g VPE/PU: 1	

	25.0245.02	FitFRAME LED Steuerung Bluetooth	FitFRAME LED control bluetooth	
		auf Kühlkörper inkl. Befestigungsclip	on cooling element incl. assembly clip	
		B/W: 29 mm H: 32 mm T/D/L: 100 mm	91 g VPE/PU: 1	

	FitFRAME LED Patchkabel	FitFRAME LED patch cable		
	25.2025.07 ← L = 250 mm 25.2050.07 ← L = 500 mm 25.2100.07 ← L = 1000 mm 25.2150.07 ← L = 1500 mm 25.2200.07 ← L = 2000 mm 25.2300.07 ← L = 3000 mm 25.2500.07 ← L = 5000 mm	L = 250 mm L = 500 mm L = 1000 mm L = 1500 mm L = 2000 mm L = 3000 mm L = 5000 mm		
		28/30/61/90/122/183/305 g	VPE/PU: 1	

	FitFRAME LED Taster Bluetooth	FitFRAME LED switch bluetooth		
	für LED Steuerung Bluetooth 25.0245.03 ← weiß 25.0245.04 ← schwarz	for LED control bluetooth white black		
		B/W: 90 mm H: 20 mm T/D/L: 90 mm	110 g VPE/PU: 1	

	25.3060.00	FitFRAME LED Kabeldurchführung	FitFRAME LED cable bushing	
		Edelstahlfinish Ø 60 mm	satın stainless steel Ø 60 mm	
		H: 25 mm	130 g VPE/PU: 1	

	29.0914.45	FitFRAME Befestigungsclip	FitFRAME assembly clip	
		Kunststoff lichtgrau	plastics light-grey	
		B/W: 10 mm H: 18 mm T/D/L: 35 mm	27 g VPE/PU: 4	

	25.3071.44	FitFRAME LED Zugentlastung	FitFRAME LED strain-relief	
		Kunststoff	plastics	
		B/W: 10 mm H: 18 mm T/D/L: 35 mm	27 g VPE/PU: 4	

SIGN-WARE®

GERMANY

It's my system.

SIGN-WARE GMBH & CO. KG

SILBACHSTR. 28

59846 SUNDERN

TEL +49 2933 92226-0

FAX +49 2933 92226-18

E-MAIL INFO@SIGN-WARE.DE

WWW.SIGN-WARE.DE